

## PRODUCT FEATURES

- High short circuit capability, self limiting short circuit current
- IGBT CHIP(Highly rugged SPT+ design)
- $V_{CE(sat)}$  with positive temperature coefficient
- Ultra Low Loss, High Ruggedness
- Free wheeling diodes with fast and soft reverse recovery
- Temperature sense included

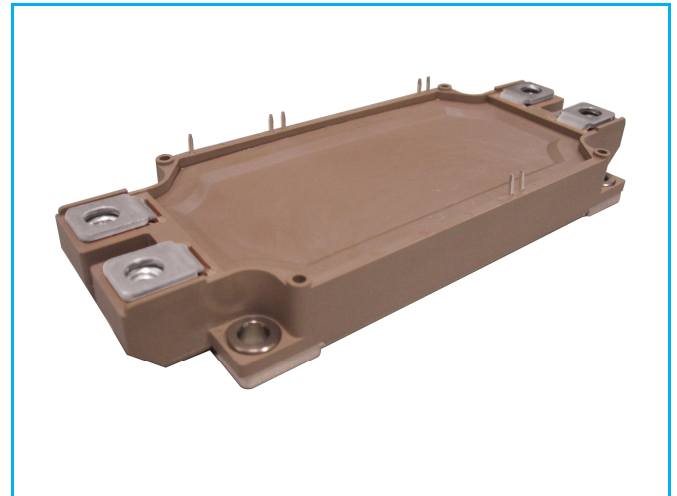

## APPLICATIONS

- AC motor control
- Motion/servo control
- Inverter and power supplies
- Photovoltaic/Fuel cell

### IGBT-inverter

ABSOLUTE MAXIMUM RATINGS ( $T_C = 25^\circ\text{C}$  unless otherwise specified)

Symbol	Parameter/Test Conditions	Values	Unit
$V_{CES}$	Collector Emitter Voltage	$T_J = 25^\circ\text{C}$	V
$V_{GES}$	Gate Emitter Voltage		
$I_C$	DC Collector Current	$T_C = 25^\circ\text{C}, T_{Jmax} = 175^\circ\text{C}$	900
		$T_C = 100^\circ\text{C}, T_{Jmax} = 175^\circ\text{C}$	600
$I_{CM}$	Repetitive Peak Collector Current	$t_p = 1\text{ms}$	1200
$P_{tot}$	Power Dissipation Per IGBT	$T_C = 25^\circ\text{C}, T_{Jmax} = 175^\circ\text{C}$	3750

### Diode-inverter

ABSOLUTE MAXIMUM RATINGS ( $T_C = 25^\circ\text{C}$  unless otherwise specified)

Symbol	Parameter/Test Conditions	Values	Unit
$V_{RRM}$	Repetitive Reverse Voltage	$T_J = 25^\circ\text{C}$	V
$I_{F(AV)}$	Average Forward Current		A
$I_{FRM}$	Repetitive Peak Forward Current	$t_p = 1\text{ms}$	
$I^2t$		$T_J = 150^\circ\text{C}, t = 10\text{ms}, V_R = 0\text{V}$	$\text{A}^2\text{S}$

MacMic Science & Technology Co., Ltd.

Add: #18, Hua Shan Zhong Lu, New District, Changzhou City, Jiangsu Province, P. R. of China

# MMG600WB170B

## IGBT-inverter

### ELECTRICAL CHARACTERISTICS ( $T_C=25^\circ\text{C}$ unless otherwise specified)

Symbol	Parameter/Test Conditions		Min.	Typ.	Max.	Unit	
$V_{GE(th)}$	Gate Emitter Threshold Voltage	$V_{CE}=V_{GE}, I_C=24\text{mA}$	5.4	6.2	7.4	V	
$V_{CE(sat)}$	Collector Emitter Saturation Voltage	$I_C=600\text{A}, V_{GE}=15\text{V}, T_J=25^\circ\text{C}$		2.25	2.6		
		$I_C=600\text{A}, V_{GE}=15\text{V}, T_J=125^\circ\text{C}$		2.55			
		$I_C=600\text{A}, V_{GE}=15\text{V}, T_J=150^\circ\text{C}$		2.6			
$I_{CES}$	Collector Leakage Current	$V_{CE}=1700\text{V}, V_{GE}=0\text{V}, T_J=25^\circ\text{C}$			3	mA	
		$V_{CE}=1700\text{V}, V_{GE}=0\text{V}, T_J=150^\circ\text{C}$			20	mA	
$I_{GES}$	Gate Leakage Current	$V_{CE}=0\text{V}, V_{GE}=\pm 15\text{V}, T_J=25^\circ\text{C}$	-500		500	nA	
$Q_g$	Gate Charge	$V_{CE}=900\text{V}, I_C=600\text{A}, V_{GE}=\pm 15\text{V}$		4		$\mu\text{C}$	
$C_{ies}$	Input Capacitance	$V_{CE}=25\text{V}, V_{GE}=0\text{V}, f=1\text{MHz}$		36.6		nF	
$C_{res}$	Reverse Transfer Capacitance				2.15		nF
$t_{d(on)}$	Turn on Delay Time	$V_{CC}=900\text{V}, I_C=600\text{A}$ $R_G=2.4\Omega,$ $V_{GE}=\pm 15\text{V},$ Inductive Load	$T_J=25^\circ\text{C}$		210		ns
			$T_J=150^\circ\text{C}$		250		ns
$t_r$	Rise Time		$T_J=25^\circ\text{C}$		190		ns
			$T_J=150^\circ\text{C}$		200		ns
$t_{d(off)}$	Turn off Delay Time		$T_J=25^\circ\text{C}$		630		ns
			$T_J=150^\circ\text{C}$		730		ns
$t_f$	Fall Time	$T_J=25^\circ\text{C}$		180		ns	
		$T_J=150^\circ\text{C}$		320		ns	
$E_{on}$	Turn on Energy	$T_J=25^\circ\text{C}$		270		mJ	
		$T_J=125^\circ\text{C}$		340		mJ	
		$T_J=150^\circ\text{C}$		350		mJ	
$E_{off}$	Turn off Energy	$T_J=25^\circ\text{C}$		152		mJ	
		$T_J=125^\circ\text{C}$		200		mJ	
		$T_J=150^\circ\text{C}$		215		mJ	
$I_{SC}$	Short Circuit Current	$tpsc \leq 10\mu\text{S}, V_{GE}=15\text{V}$ $T_J=150^\circ\text{C}, V_{CC}=1000\text{V}$		1920		A	
$R_{thJC}$	Junction to Case Thermal Resistance ( Per IGBT )				0.04	K/W	

## Diode-inverter

### ELECTRICAL CHARACTERISTICS ( $T_C=25^\circ\text{C}$ unless otherwise specified)

Symbol	Parameter/Test Conditions		Min.	Typ.	Max.	Unit
$V_F$	Forward Voltage	$I_F=600\text{A}, V_{GE}=0\text{V}, T_J=25^\circ\text{C}$		1.8	2.2	V
		$I_F=600\text{A}, V_{GE}=0\text{V}, T_J=125^\circ\text{C}$		1.9		
		$I_F=600\text{A}, V_{GE}=0\text{V}, T_J=150^\circ\text{C}$		1.95		
$t_{rr}$	Reverse Recovery Time	$I_F=600\text{A}, V_R=900\text{V}$		1200		ns
$I_{RRM}$	Max. Reverse Recovery Current	$dI_F/dt=-3000\text{A}/\mu\text{s}$		360		A
$Q_{RR}$	Reverse Recovery Charge	$T_J=150^\circ\text{C}$		215		$\mu\text{C}$
$E_{rec}$	Reverse Recovery Energy			140		mJ
$R_{thJCD}$	Junction to Case Thermal Resistance ( Per Diode )				0.09	K/W

# MMG600WB170B

## NTC CHARACTERISTICS ( $T_C=25^\circ\text{C}$ unless otherwise specified)

Symbol	Parameter/Test Conditions	Min.	Typ.	Max.	Unit
$R_{25}$	Resistance $T_C=25^\circ\text{C}$		5		K $\Omega$
$B_{25/50}$	$R_2 = R_{25} \exp [B_{25/50}(1/T_2 - 1/(298.15 \text{ K}))]$		3375		K

## MODULE CHARACTERISTICS ( $T_C=25^\circ\text{C}$ unless otherwise specified)

Symbol	Parameter/Test Conditions	Values	Unit	
$T_{Jmax}$	Max. Junction Temperature	175	°C	
$T_{Jop}$	Operating Temperature	-40~150		
$T_{stg}$	Storage Temperature	-40~125		
$V_{isol}$	Isolation Breakdown Voltage	AC, 50Hz(R.M.S), t=1minute	4000	V
CTI	Comparative Tracking Index		> 225	
Torque	to heatsink	Recommended (M5)	2.5~5	Nm
	to terminal	Recommended (M6)	3~5	Nm
Weight			350	g

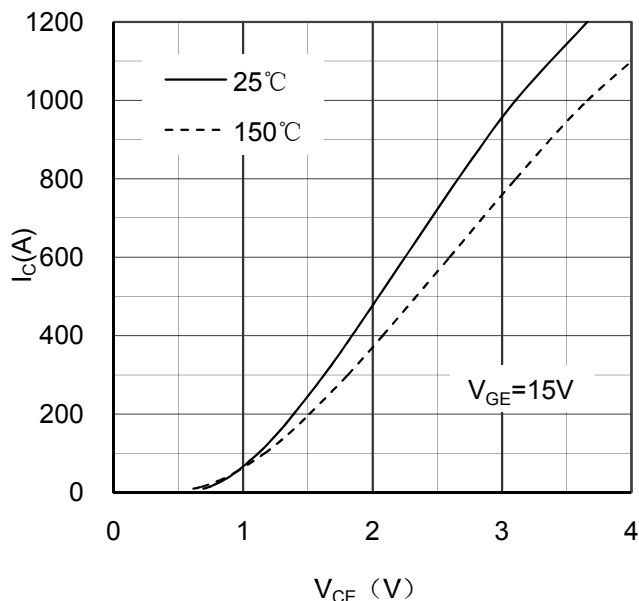

Figure 1. Typical Output Characteristics IGBT-inverter

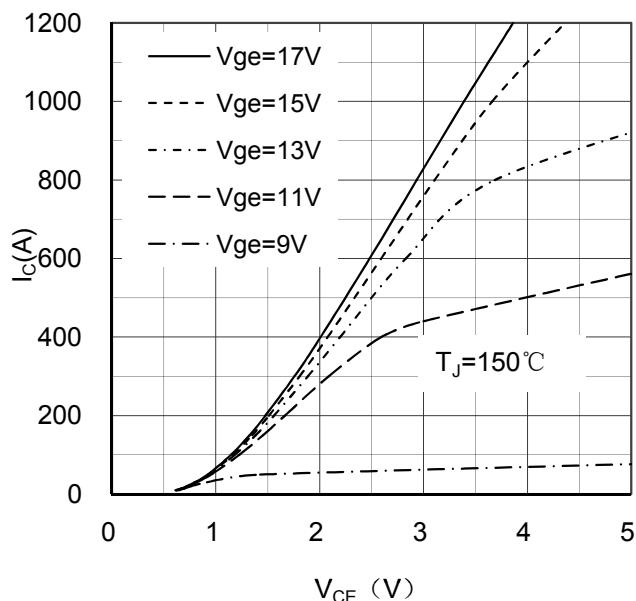

Figure 2. Typical Output Characteristics IGBT-inverter

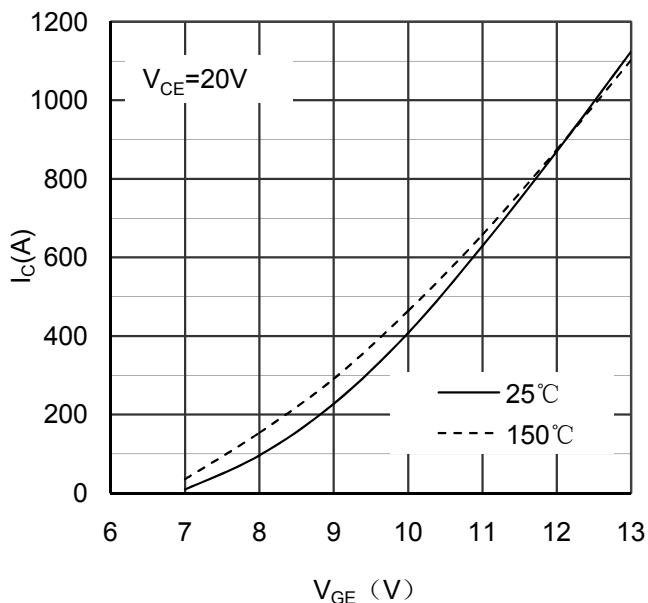

Figure 3. Typical Transfer characteristics IGBT-inverter

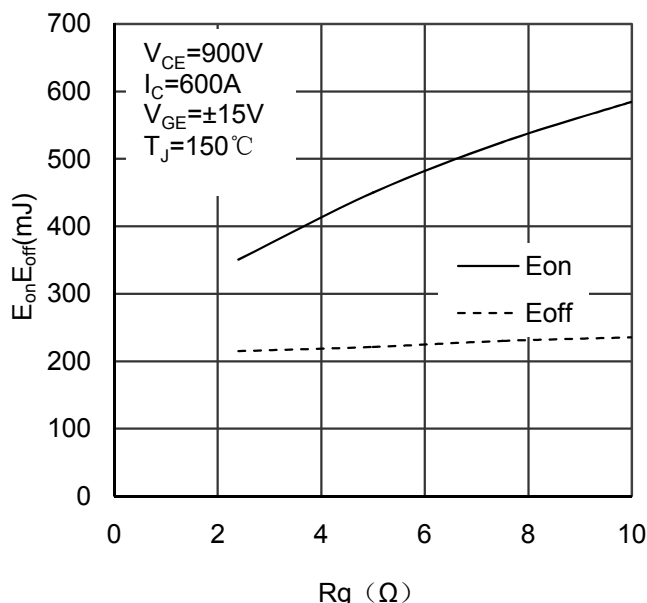

Figure 4. Switching Energy vs Gate Resistor IGBT-inverter

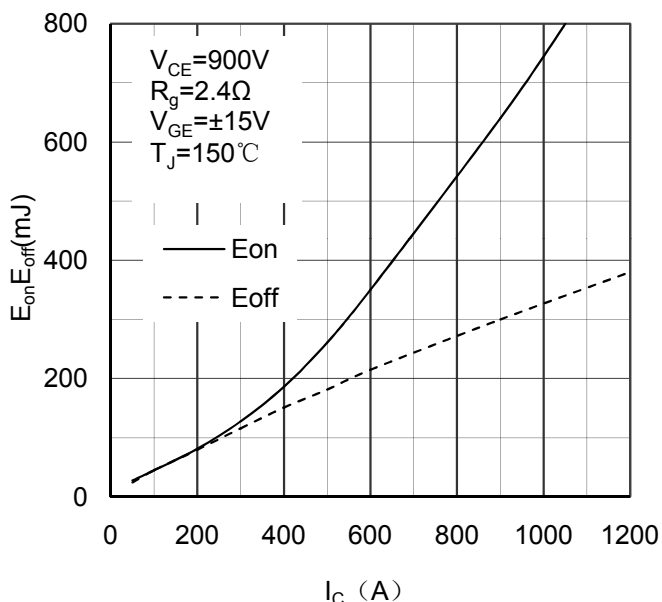

Figure 5. Switching Energy vs Collector Current IGBT-inverter

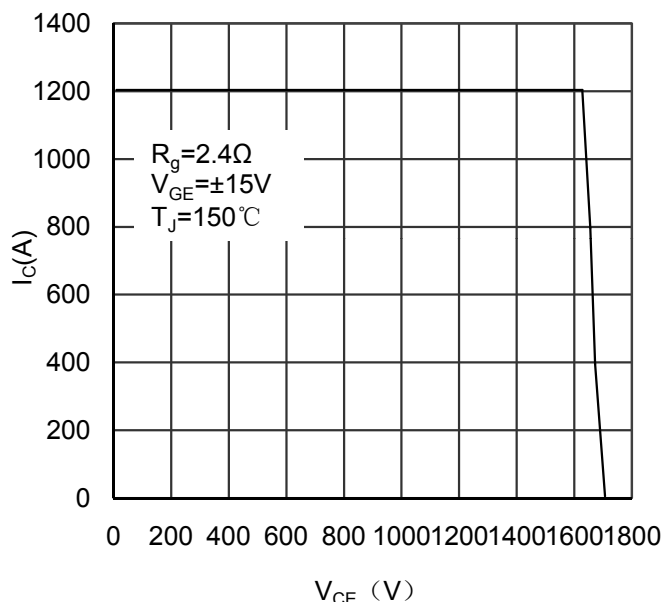

Figure 6. Reverse Biased Safe Operating Area IGBT-inverter

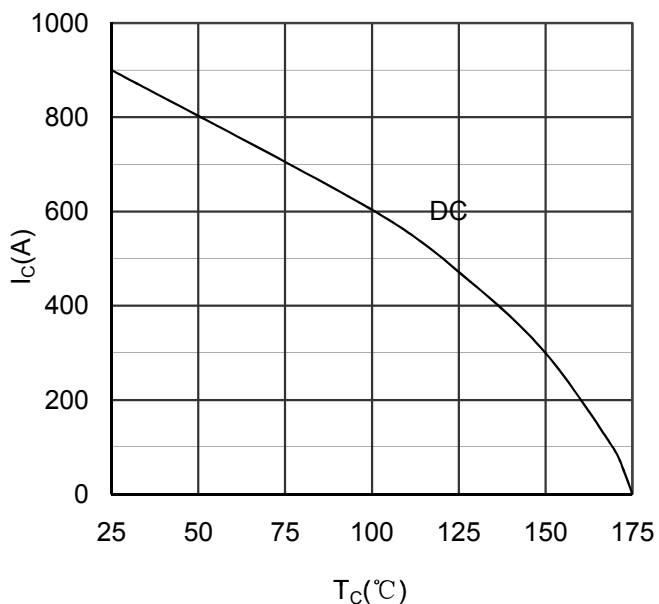

Figure 7. Collector Current vs Case temperature IGBT-inverter

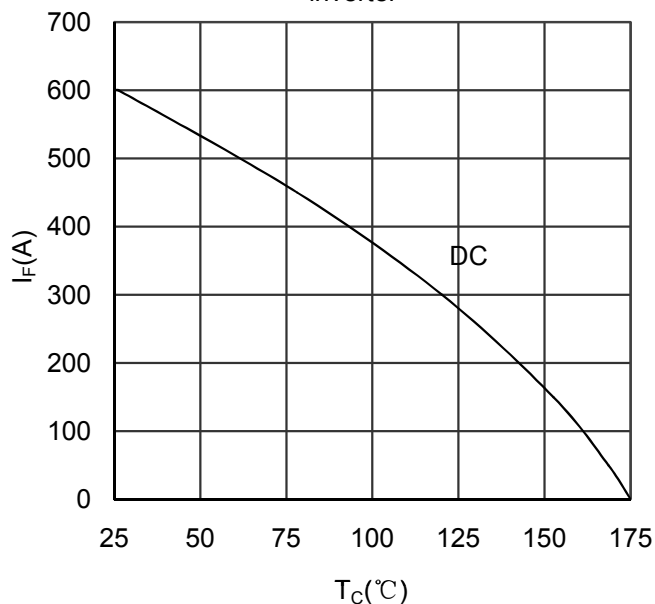

Figure 8. Forward current vs Case temperature Diode-inverter

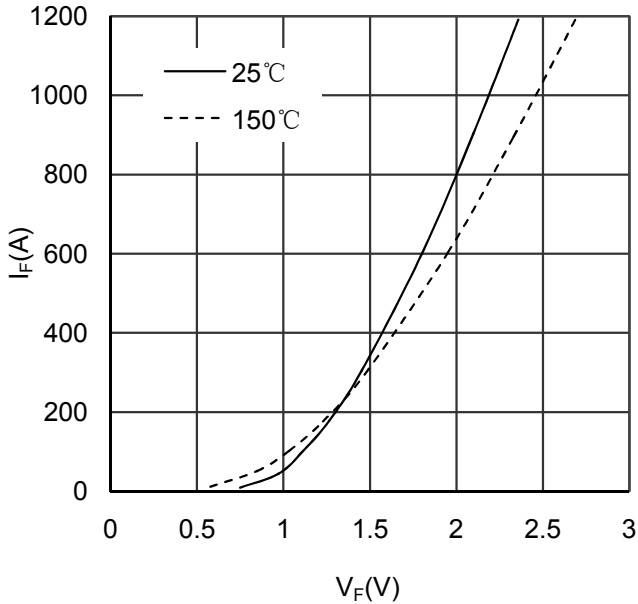

Figure 9. Diode Forward Characteristics Diode -inverter

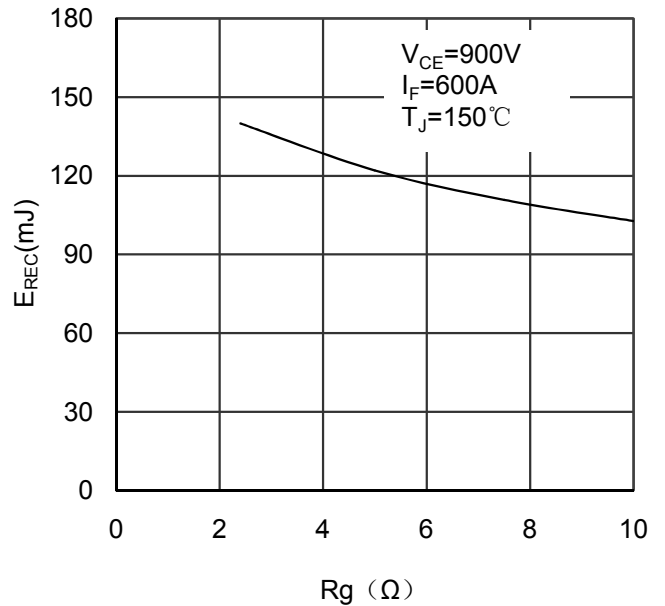

Figure 10. Switching Energy vs Gate Resistor Diode -inverter

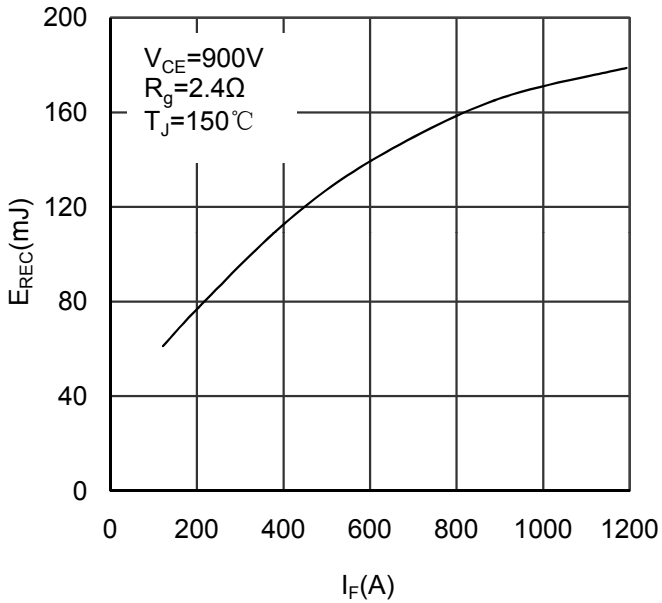

Figure 11. Switching Energy vs Forward Current Diode-inverter

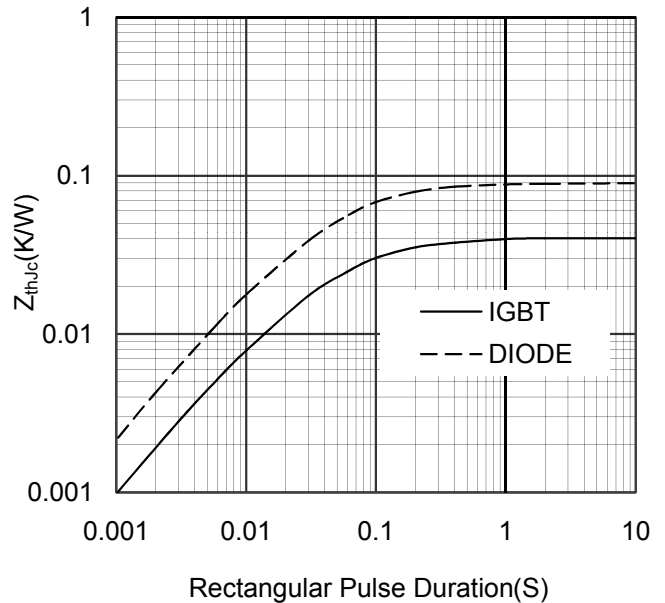

Figure 12. Transient Thermal Impedance of Diode and IGBT-inverter

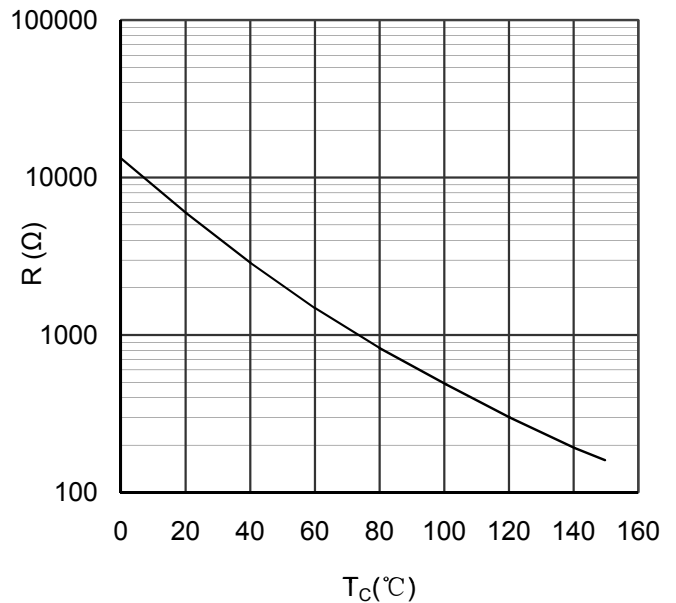

Figure 13. NTC Characteristics

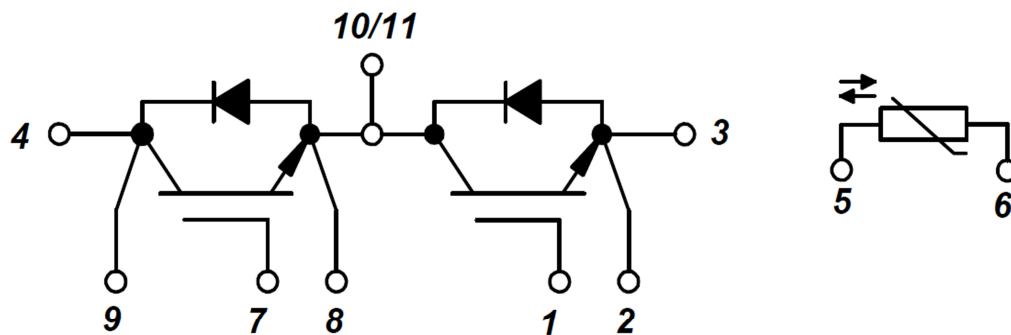
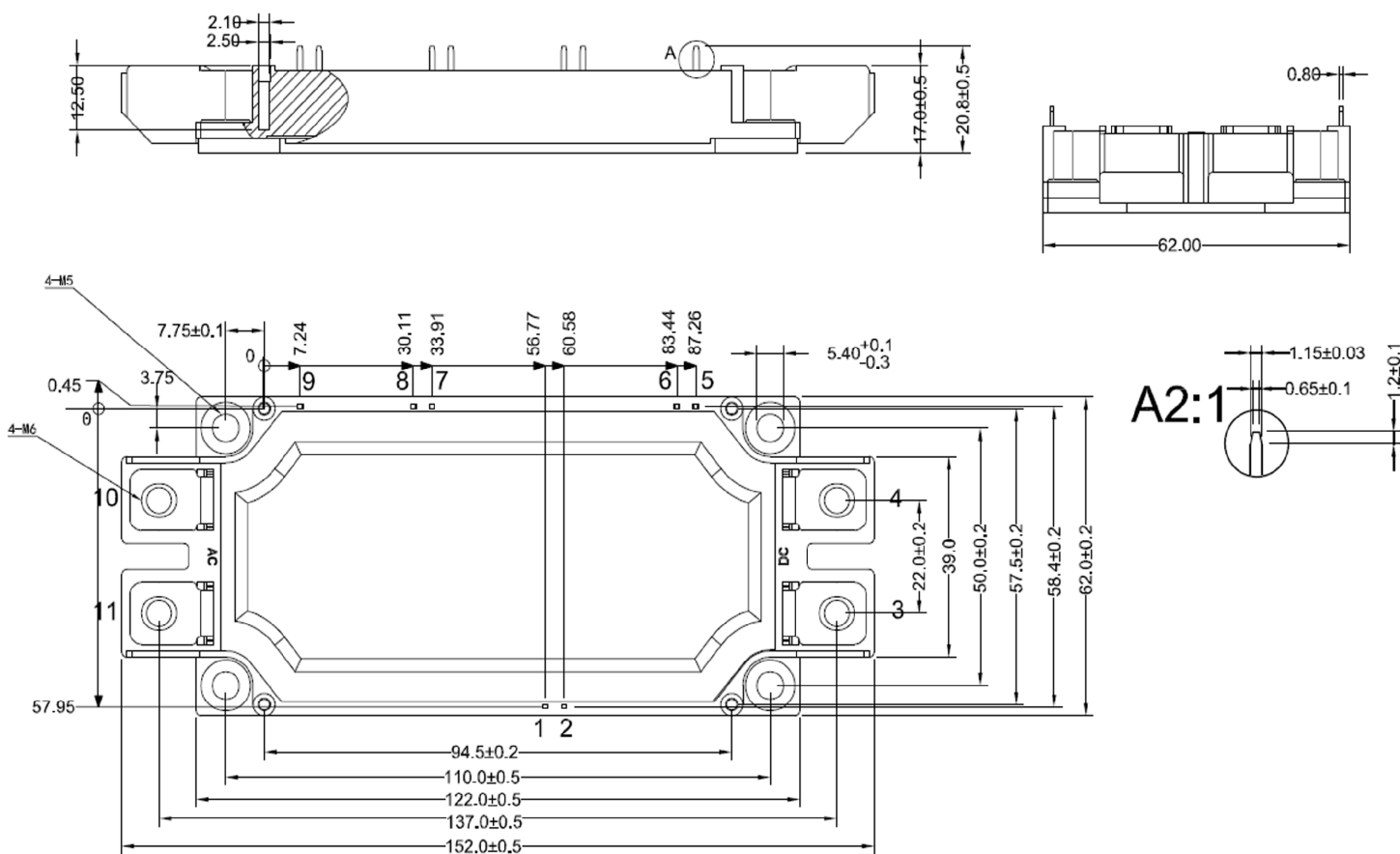

Figure 14. Circuit Diagram



Dimensions in (mm)

Figure 15. Package Outline